



LMP-1204G-SFP-bt Series

12-Port Industrial Gigabit IEEE 802.3bt PoE++ Light Layer 3 Managed Ethernet Switch, w/4*10/100/1000Tx (90W/Port), 4*10/100/1000Tx (30W/Port), and 4*100/1000 SFP Slots



Hardware Manual

Version 1.0
(August 2020)



© Copyright 2020 Antaira Technologies, LLC.

All Rights Reserved

This document contains information, which is protected by copyright. Reproduction, adaptation or translation without prior permission is prohibited, except as allowed under the copyright laws.

Trademark Information

Antaira is a registered trademark of Antaira Technologies, LLC., Microsoft Windows and the Windows logo are the trademarks of Microsoft Corp. NetWare is the registered trademark of Novell Inc. WMM and WPA are the registered trademarks of Wi-Fi Alliance. All other brand and product names are trademarks or registered trademarks of their respective owners.

Notice: Copyrights © 2020 by Antaira Technologies, LLC. All rights reserved. Reproduction, adaptation, or translation without prior permission of Antaira Technologies, LLC. is prohibited, except as allowed under the copyright laws.

Disclaimer

Antaira Technologies, LLC. provides this manual without warranty of any kind, expressed or implied, including but not limited to the implied warranties of merchantability and fitness for a particular purpose. Antaira Technologies, LLC. may make improvements and/or changes to the product and/or specifications of the product described in this manual, without prior notice. Antaira Technologies, LLC. will not be liable for any technical inaccuracies or typographical errors found in this guide. Changes are periodically made to the information contained herein and will be incorporated into later versions of the manual. The information contained is subject to change without prior notice.

FCC Warning

This equipment has been tested and found to comply with the limits for a Class-A digital device, pursuant to Part 15 of the FCC rules. These limits are designed to provide reasonable protection against harmful interference in a residential installation. This equipment generates, uses, and can radiate radio frequency energy. It may cause harmful interference to radio communications if the equipment is not installed and used in accordance with the instructions. However, there is no guarantee that interference will not occur in a particular installation. If this equipment does cause harmful interference to radio or television reception, which can be determined by turning the equipment off and on, the user is encouraged to try to correct the interference by one or more of the following measures:

- Reorient or relocate the receiving antenna.
- Increase the separation between the equipment and receiver.
- Connect the equipment into an outlet on a circuit different from that to which the receiver is connected.
- Consult the dealer or an experienced radio/TV technician for help.

Caution: Any changes or modifications not expressly approved by the grantee of this device could void the user's authority to operate the equipment.

Avertissement FCC

Cet équipement a été testé et déclaré conforme aux limites d'un appareil numérique de classe A, conformément à la partie 15 des règles de la FCC. Ces limites sont conçues pour fournir une protection raisonnable contre les interférences nuisibles dans une installation résidentielle. Cet équipement génère, utilise et peut émettre de l'énergie radiofréquence. Cela peut provoquer des interférences nuisibles aux communications radio si l'équipement n'est pas installé et utilisé conformément aux instructions. Cependant, il n'y a aucune garantie qu'aucune interférence ne se produira dans une installation particulière. Si cet équipement provoque des interférences nuisibles à la réception radio ou télévision, ce qui peut être déterminé en éteignant puis en rallumant l'équipement, l'utilisateur est encouragé à essayer de corriger les interférences par une ou plusieurs des mesures suivantes:

- Réorientez ou déplacez l'antenne de réception.
- Augmentez la distance entre l'équipement et le récepteur.
- Connectez l'équipement à une prise sur un circuit différent de celui auquel le récepteur est connecté.
- Consultez le revendeur ou un technicien radio / TV expérimenté pour obtenir de l'aide.

Attention: Tout changement ou modification non expressément approuvé par le bénéficiaire de cet appareil peut annuler le droit de l'utilisateur à utiliser l'équipement.

CE Mark Warning

This is a Class-A product. In a domestic environment this product may cause radio interference in which case the user may be required to take adequate measures.

Avertissement de marque CE

Ceci est un produit de classe A. Dans un environnement domestique, ce produit peut provoquer des interférences radio, auquel cas l'utilisateur peut être amené à prendre des mesures adéquates.

Industrial Ethernet Switches

Industrial Grade Gigabit PoE++ Managed Ethernet Switches

Hardware Manual

Version 1.0 (August 2020)

This manual supports the following models:

- LMP-1204G-SFP-bt
- LMP-1204G-SFP-bt-T

Table of Contents

1. Introduction	1
1.1 Product Overview	1
1.2 Product Software Features.....	1
1.3 Product Hardware Features	2
1.4 Package Contents	2
1.5 Safety Precaution	3
2. Hardware Description	4
2.1 Physical Dimensions	4
2.2 Front Panel.....	5
2.3 Top View	5
2.4 LED Indicators.....	6
2.5 PoE Port LED Indicators	7
2.6 Dip Switch	9
2.7 Relay Contact Alarm Warning.....	9
2.8 Reset Button.....	9
2.9 Ethernet Ports	10
2.10 Cabling	10
2.11 Wiring the Power Inputs	11
2.12 Wiring the Fault Alarm Contact	13
2.13 Grounding Note	13
3. Mounting Installation	14
3.1 DIN-Rail Mounting	14
3.2 Wall Mounting.....	15
4. Hardware Installation.....	16
4.1 Installation Steps	16
4.2 Maintenance and Service.....	17
5. Technical Specifications	18

1. Introduction

All Antaira industrial managed switches come with a pre-installed “user-friendly” web console interface, which allows users to easily configure and manage the units, whether one is using a serial console and Command Line Interface (CLI) commands like Telnet, SSH, HTTP (Web GUI) or Simple Network Management Protocols (SNMP).

1.1 Product Overview

Antaira Technologies’ LMP-1204G-SFP-bt series is a 12-port industrial Gigabit PoE++ managed Ethernet switch embedded with 4*10/100/1000Tx Ethernet ports that support IEEE 802.3bt for a maximum of 90W/port, 4*10/100/1000Tx Ethernet ports that support IEEE 802.3af/at for a maximum of 30W/port, and 4*100/1000Fx fiber connection. The LMP-1204G-SFP-bt series is a fully manageable Light Layer 3 Ethernet switch that is pre-loaded with a user-friendly web management console design. It supports the ring network redundancy function using the market’s open standard ITU-T G.8032 ERPS (Ethernet Ring Protection Switch) protocol that has a <50ms network recovery time. The advanced network filtering and security functions, such as IGMP, VLAN, QoS, SNMP, RMON, Modbus TCP, and 802.1X/HTTPS/SSH/SSL increase determinism and improve network management for remote SCADA systems or control networks.

The LMP-1204G-SFP-bt series is IP30 rated and DIN-rail mountable. There are also two wide operating temperature models for either a standard temperature range (STD: -10°C to 65°C) or an extended temperature range (EOT: -40°C to 75°C). It also provides high EFT and ESD protection for industrial networking applications, such as power/utility, water wastewater, oil/gas/mining, factory automation, security surveillance, ITS and any other outdoor or harsh environment.

1.2 Product Software Features

- Network Redundancy
 - STP, RSTP, MSTP, ITU-T G.8032 Ethernet Ring Protection Switch (ERPS) for network redundancy
- Network Management
 - Web UI based management, SNMP v1/v2/v3, Serial Console
 - Qos, traffic classification QoS, Cos, bandwidth control for Ingress and Egress, broadcast storm control, DiffServ
 - IEEE802.1q VLAN tagging, port-based VLAN support

- IGMP snooping v1/v2/v3, IGMP filtering / throttling, IGMP query up to 1024group
- Supports IPv4/IPv6, RMON, MIB II, port mirroring, event syslog, DNS, NTP, HTTPS, SSH/SSL, TFTP
- MODBUS TCP for SCADA system integration
- Port Configuration
 - Status, statistics, mirroring, rate limiting, event syslog
- Event Handling
 - Event notification: Cold/Warm Start, Power Failure, Authentication, SNMP trap and Fault Alarm Relay Output
- Software Upgrade via TFTP and HTTP
- Configuration Backup – USB Port

1.3 Product Hardware Features

- System Interface and Performance
 - All RJ45 ports support Auto MDI/MDI-X Function
 - Embedded 4*10/100/1000Tx (PSE: 90W/Port) RJ45 ports, 4*10/100/1000Tx (PSE: 30W/Port) RJ45 ports, and 4*100/1000 SFP slots
 - Store-and-forward switching architecture
 - 8K MAC address table
 - Supports 9.6Kbytes Jumbo Frame
 - 4Mbits memory buffer
- Power Input
 - DC 48~55V redundant, with a 6-pin removal terminal block, with SELV output certified by UL61010-2-201
 - It is recommended to use a UL listed industrial power supply
- Operating Temperature
 - Standard operating temperature model: -10°C to 65°C
 - Extended operating temperature model: -40°C to 75°C
- Case/Installation
 - IP30 protection
 - DIN-Rail and wall mount design

1.4 Package Contents

- LMP-1204G-SFP-bt(-T)
- Quick Installation Guide
- Wall mounting bracket set with screws

- DC cable – 18 AWG & DC jack 5.5 x 2.1mm
- RJ45 to DB9 serial console cable

1.5 Safety Precaution

Attention: If the DC voltage is supplied by an external circuit, please use a protection device on the power supply input. The industrial Ethernet switch's hardware specs, ports, cabling information, and wiring installation will be described within this user manual.

Attention: Si la tension CC est fournie par un circuit externe, veuillez utiliser un dispositif de protection sur l'entrée d'alimentation. Les spécifications matérielles, les ports, les informations de câblage et l'installation du câblage du commutateur Ethernet industriel seront décrits dans ce manuel d'utilisation.

Warning Labels

The caution label means that you should check the certain information on user manual when working with the device. (Shown in Figure 1.1)

Étiquettes d'avertissement

L'étiquette d'avertissement signifie que vous devez vérifier certaines informations sur le manuel d'utilisation lorsque vous travaillez avec l'appareil. (Montré dans la figure 1.1)



Figure 1.1 - Caution Label
Figure 1.1 - Étiquette de mise en garde



Figure 1.2 - Hot Surface Warning Label
Figure 1.2 - Étiquette d'avertissement de surface chaude

2. Hardware Description

2.1 Physical Dimensions

Figure 2.1, below, shows the physical dimensions of Antaira's LMP-1204G-SFP-bt series:

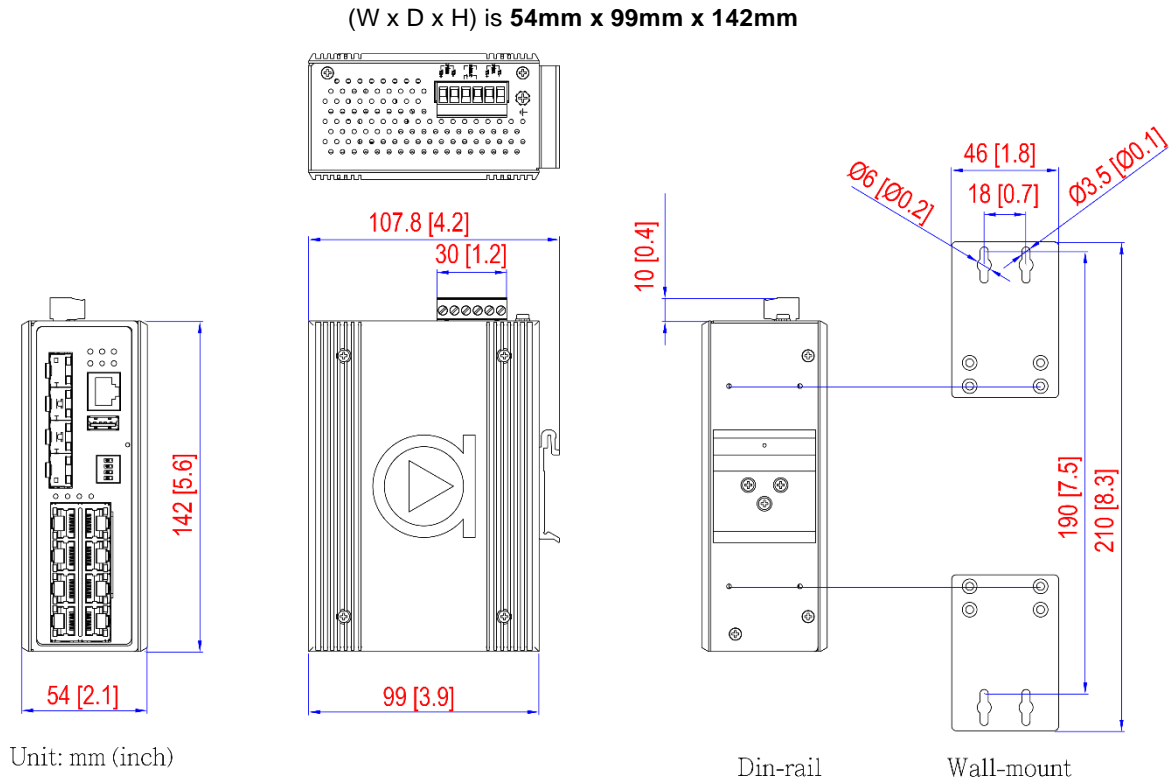

Figure 2.1
 LMP-1204G-SFP-bt Series Physical Dimensions

2.2 Front Panel

The front panel of the LMP-1204G-SFP-bt series industrial gigabit PoE++ managed Ethernet switch is shown below in *Figure 2.2*.

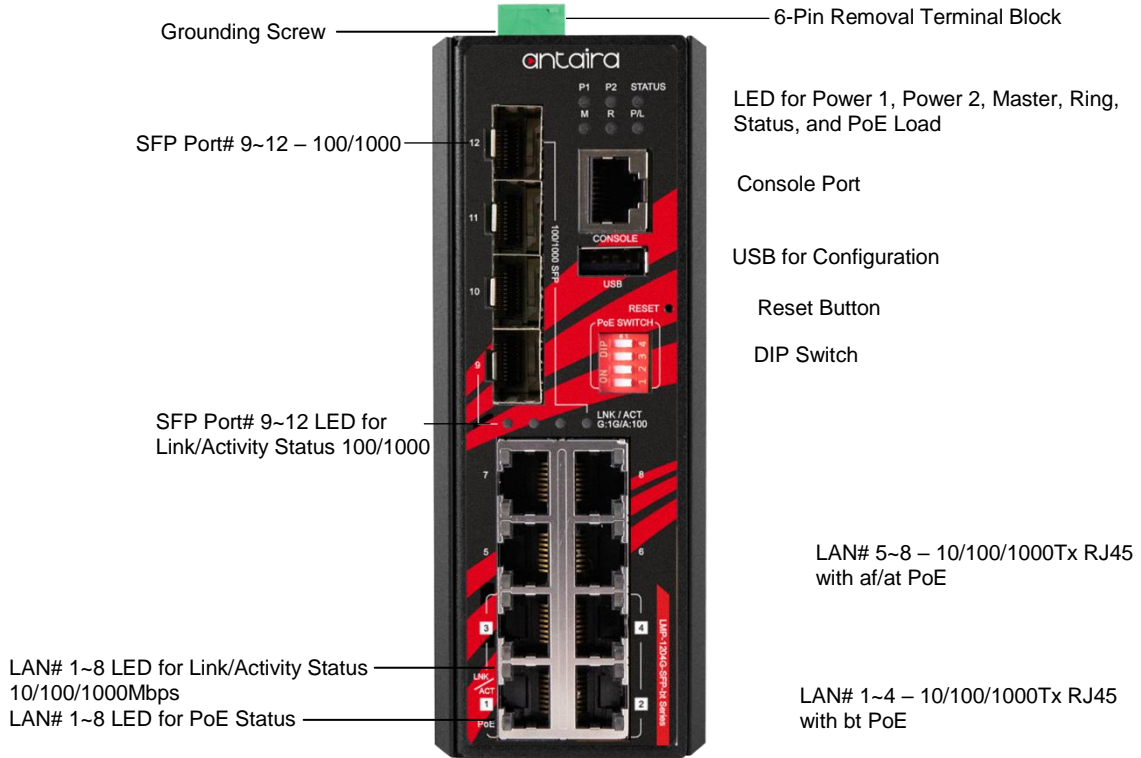

Figure 2.2 - The Front Panel of LMP-1204G-SFP-bt Series

2.3 Top View

Figure 2.3, below, shows the top panel of the LMP-1204G-SFP-bt series switch that is equipped with one 6-pin removal terminal block connector for dual DC power inputs (48~55VDC).

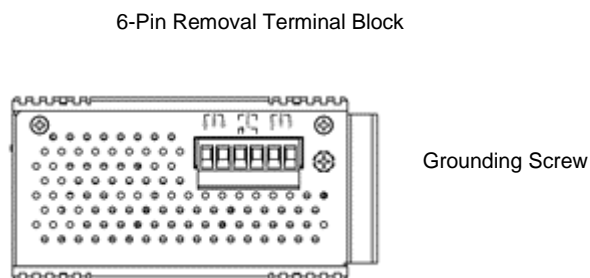

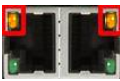



Figure2.3

Top Panel View of LMP-1204G-SFP-bt Series

2.4 LED Indicators

There are LED light indicators located on the front panel of the industrial Ethernet switch that display the power status and network status. Each LED indicator has a different color and has its own specific meaning, see below in *Table 2.1*.

LED	Color	Description	
P1	Green	On	Power input 1 is active
		Off	Power input 1 is inactive
P2	Green	On	Power input 2 is active
		Off	Power input 2 is inactive
Status	Green	On	No event happened
	Red	On	System booting Event happened by software setting
Master	Green	On	ERPS Owner Mode (Ring Master) is ready
		Off	ERPS Owner Mode is not active
Ring	Green	On	ERPS Ring Network is active
		Flashing	ERPS Ring Network works abnormally or misconfigure
		Off	ERPS Ring Network is not active
PoE Load (Max: 240W)	-	Off	PoE Load \leq 50%
	Blue	On	PoE Load 51-70%
	Red	On	PoE Load 71-90%
	Red	Flashing	PoE Load 91-100%
LAN Port 1~8 (Upper LED)		On	Connected to network, 1000Mbps
		Flashing	Networking is active
		Off	Not connected to network
		On	Connected to network, 10/100Mbps
		Flashing	Networking is active
		Off	Not connected to network
LAN Port 1~4 bt PoE Mode (Lower LED)		On	IEEE 802.3bt connection (Single Signature PD Class 5~8/Dual Signature PD Channel Class 1~5)
		Off	No powered-device attached or power supplying fails
		Flashing	Port link is recovered from failure event
		On	IEEE 802.3af/at connection (Single Signature PD Class 0~4)
		Off	No powered-device attached or power supplying fails
		Flashing	Port link is recovered from failure event



		Alternating Flashing	The port is trying to recover from event failure (Frequency: 20secs/time)
LAN Port 5~8 at PoE Mode (Lower LED)		On	Supplying PoE at (30W)/af power to the powered-device
		Off	Not connected to a powered device
		Alternating Flashing	The port is trying to recover from event failure (Frequency: 20secs/time)
SFP Port 9~12	Green	On	Connected to network, 1000Mbps
		Flashing	Networking is active
		Off	Not connected to network
	Amber	On	Connected to network, 100Mbps
		Flashing	Networking is active
		Off	Not connected to network

Table 2.1 - LED Indicators for LMP-1204G-SFP-bt Series

Note: "P1" is the abbreviation for "Power 1", "P2" is for "Power 2", "LNK" is for "Link", and "ACT" is for "Activity".

2.5 PoE Port LED Indicators

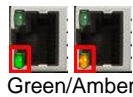
The LED light indicators on the PoE copper port can help the user know if an event once occurs or is happening. When the event is happening, user can verify the event from the Dual-color LED status. If the port has recovered from an event, user can verify the event from the blinking frequency of the PoE LED (5 seconds as a cycle).

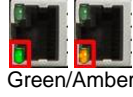
- **Power Budget Exceeded Event**

When the total PoE budget is overload (>100%), the PoE port of the lowest priority PoE port will be shutdown. The PoE LED of the port will act cyclically as below until the port is recovered from the event:

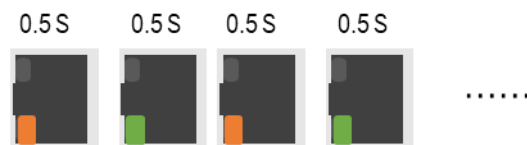

After the PoE port is recovered from the PoE budget overload event, the PoE LED of the will act cyclically as below until the event indicator is clear manually:

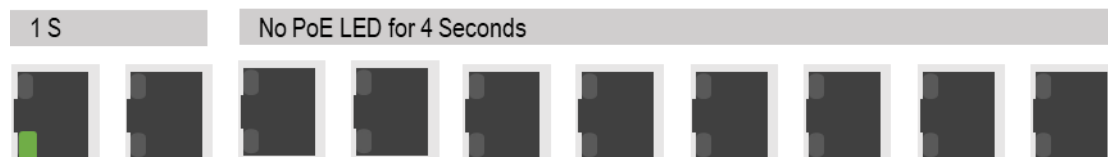

**AF/AT: Amber; BT: Green

• **PoE Port Over Current Event (PoE Port Overload Event)**

When the current limit of the specific PoE port is exceeded, the PoE power will be shutdown.
 The PoE LED of the port will act cyclically as below until the port is recovered from the event:

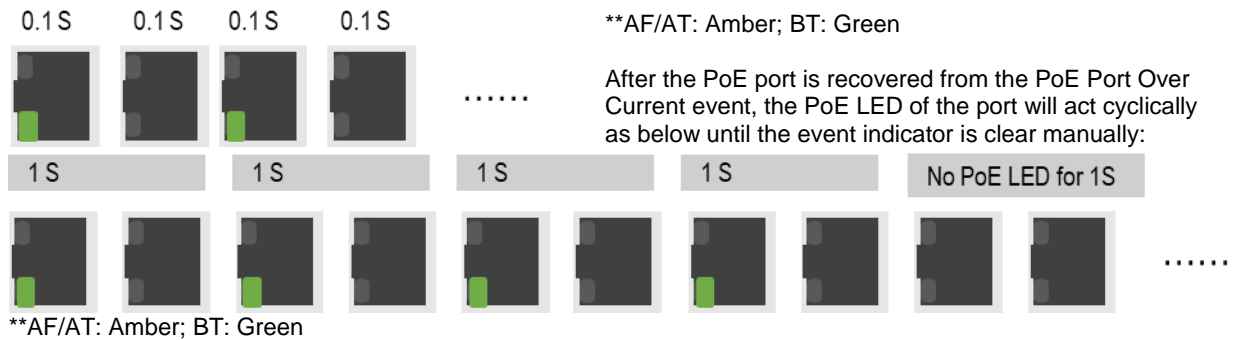

• **Cable Short Event**

When the working PD encounters a cable short event, the PoE Port LED will act cyclically as below until the port is recovered from the event:

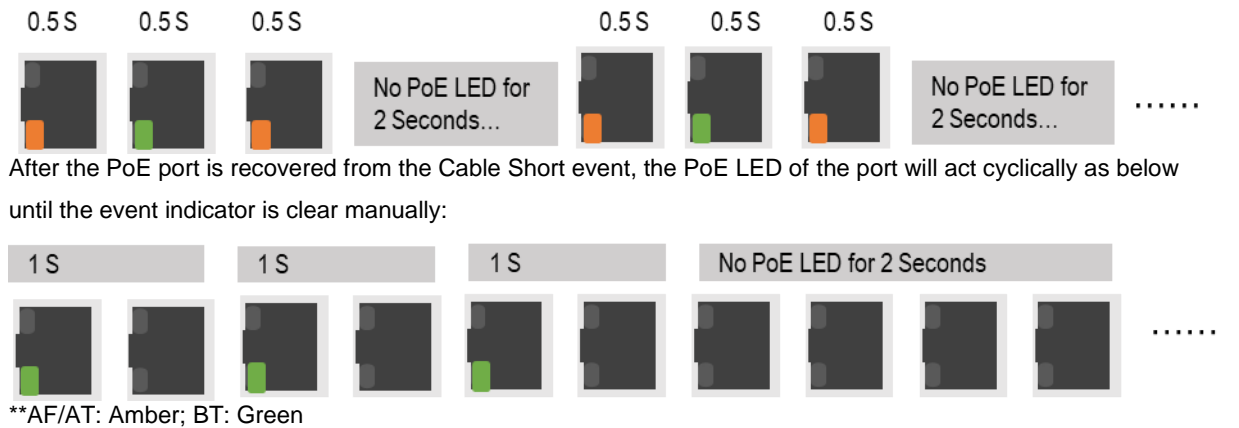

• **Dual PD Fail Event**

When one channel of the connected dual PD is failed, the failed channel will be shut down and the active channel will still supply PoE to the connected PD. The PoE Port LED will act cyclically as below until the port is recovered from the event:

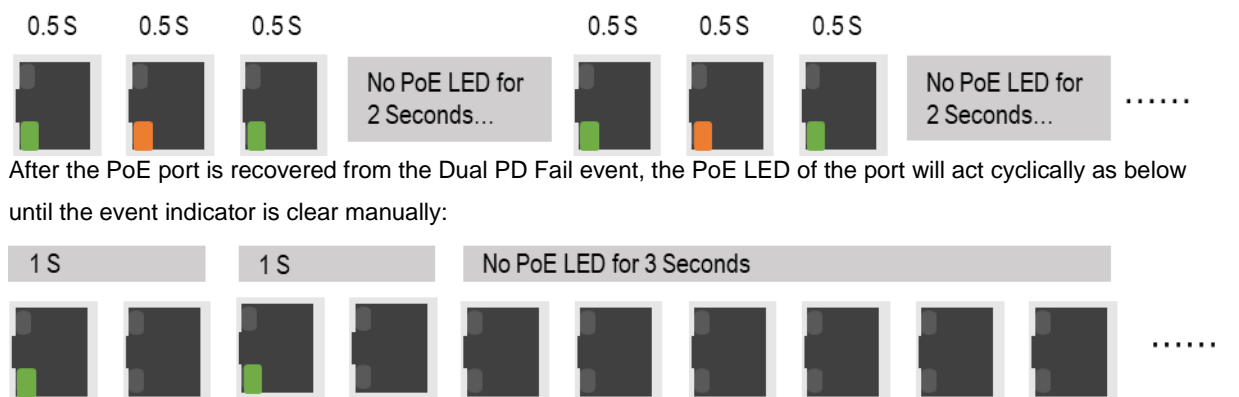

**AF/AT: Amber; BT: Green

[Notice]

1. The system will automatically retry to recover from the event failure every 20 seconds.
2. To clear the warning PoE Indicator of the recovered port, please re-plug the port cable or re-open the PoE function of the port via DIP Switch (≥ 2 sec).

2.6 Dip Switch

The 4-pin Dip Switch on the front panel of the Ethernet Switch works as the PoE controller for PoE Port 1~4.

	ON	OFF
Dip Switch 1	Enable Port 1 PoE Function	Disable Port 1 PoE Function
Dip Switch 2	Enable Port 2 PoE Function	Disable Port 2 PoE Function
Dip Switch 3	Enable Port 3 PoE Function	Disable Port 3 PoE Function
Dip Switch 4	Enable Port 4 PoE Function	Disable Port 4 PoE Function

2.7 Relay Contact Alarm Warning

2-pin 1*24VDC@1A resistive normal open on 6-pin terminal block.

The relay contact alarm will be triggered when anyone of the listed events occurs.

Key trigger event 1: Power-1 or Power-2 is inactive

Key trigger event 2: PoE total loading >100% PoE output budget

Key trigger event 3: PoE over current per port

Key trigger event 4: Cable short per port

Key trigger event 5: One of the channels in Dual PD fail

[Notice]

When the relay is triggered because of Event 2~5, the relay contact alarm, will update the status every 30 seconds. If there's no event happening for 30 seconds, the relay contact alarm will be turn off. If the user disables the failed PoE port by removing the cable or Dip Switch manually, the relay will be recovered immediately.

2.8 Reset Button

There is a 'Reset' button located on the front panel of the industrial Ethernet switch that helps users to reboot, restore default, or save start-up configurations by pressing the button for different seconds.

Please refer to *Table 2.2* for the timing and function.

Seconds	Function	Fault LED
0s < t (press time) < 4s	Reboot the switch	LED is flashing with green color

4s < t (press time) < 8s	Restore factory default	LED is flashing with green and red color
8s < t (press time)	Backup configuration to USB (startup-config)	LED is flashing with red color

Table 2.2 – Reset Button Functions

2.9 Ethernet Ports

- **RJ45 Ports**

RJ45 Ports (Auto MDI/MDIX): The RJ45 ports are auto-sensing for 10Base-T, 100Base-TX, or 1000Base-T connections. Auto MDI means that the switch can connect to another switch or workstation without changing the straight-through or crossover cabling. See the figures below for straight-through and crossover cabling schematics.

- **RJ45 Pin Assignments**

Crossover Cable		Straight Through Cable	
Pin Number / Signal	Pin Number / Signal	Pin Number / Signal	Pin Number / Signal
1 / RX+	3 / TX+	1 / RX+	1 / TX+
2 / RX-	6 / TX-	2 / RX-	2 / TX-
3 / TX+	1 / RX+	3 / TX+	3 / RX+
6 / TX-	2 / RX-	6 / TX-	6 / RX-

Table 2.3 – 10/100Base-T(X) RJ45 Pin Assignments

Crossover Cable		Straight Through Cable	
Pin Number / Signal	Pin Number / Signal	Pin Number / Signal	Pin Number / Signal
1 / TP0+	3 / TP1+	1 / TP0+	1 / TP1+
2 / TP0-	6 / TP1-	2 / TP0-	2 / TP1-
3 / TP1+	1 / TP0+	3 / TP1+	3 / TP0+
4 / TP2+	7 / TP3+	4 / TP2+	4 / TP3+
5 / TP2-	8 / TP3-	5 / TP2-	5 / TP3-
6 / TP1-	2 / TP0-	6 / TP1-	6 / TP0-
7 / TP3+	4 / TP2+	7 / TP3+	7 / TP2+
8 / TP3-	5 / TP2-	8 / TP3-	8 / TP2-

Table 2.4 – 1000Base-T RJ45 Pin Assignments

Note: “+” and “-” signs represent the polarity of the wires that make up each wire pair.

2.10 Cabling

Use the four twisted-pair, category 5e, or the above cabling for the RJ-45 port connections. The cable

between the switch and the link partner (switch, hub, workstation, etc.) must be less than 100 meters (328 ft.) in length.

The small form-factor pluggable (SFP) is a compact optical transceiver used in optical communications for both telecommunication and data communication applications.



Caution: Please employ optional optical transceiver (SFP/Fixed Fiber) that complies with IEC-60825-1 and classified as Class 1 laser product.



Attention: Veuillez utiliser un émetteur-récepteur optique en option (SFP/fibre fixe) conforme à la norme IEC-60825-1 et classé comme produit laser de classe 1.

2.11 Wiring the Power Inputs



Caution: Please follow the steps below when inserting the power wire.



Attention: Veuillez suivre les étapes ci-dessous lors de l'insertion du câble d'alimentation.

1. Insert the positive and negative wires into the PWR1 (V1+, V1-) and PWR2 (V2+, V2-) contacts on the terminal block connector as shown below in *Figure 2.6*.

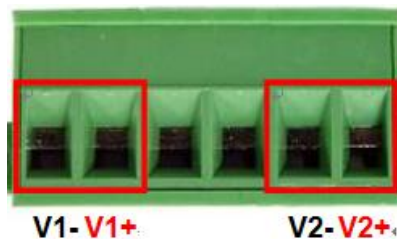

Figure 2.6
Power Terminal Block

2. Tighten the wire-clamp screws to prevent the wires from loosening, as shown below in *Figure 2.7*.



Figure 2.7
Power Terminal Block



Caution:

*Only use copper conductors, **125°C**, tighten to **5 lbs.***

*The wire gauge for the terminal block should range between **18-20 AWG**.*



Attention:

*Utilisez uniquement des conducteurs en cuivre, **125°C**, serrez à **5 lb.***

*Le calibre des fils du bornier doit être compris entre **18 et 20 AWG**.*

2.12 Wiring the Fault Alarm Contact

The fault alarm contact is in the middle of the terminal block connector as the picture shows below in *Figure 2.8*. By inserting the wires, it will detect the fault status including power failure or port link failure (managed industrial switch only) and form a normal open circuit. An example is shown below in *Figure 2.8*.

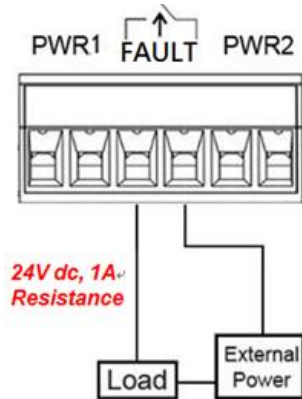

Insert the wires into the fault alarm contact (No. 3 & 4)

Figure 2.8

Wiring the Fault Alarm Contact



Caution:

- The wire gauge for the terminal block should range between 12 ~ 24 AWG.
- If only using one power source, jumper Pin 1 to Pin 5 and Pin 2 to Pin 6 to eliminate power fault alarm.



Attention:

- Le calibre des fils du bornier doit être compris entre 12 et 24 AWG.
- Si vous n'utilisez qu'une seule source d'alimentation, connectez les broches 1 à 5 et les broches 2 à 6 pour éliminer l'alarme de panne de courant.

2.13 Grounding Note

Grounding and wire routing help limit the effects of noise due to Electromagnetic Interference (EMI). Run the ground connection from the ground screw to the grounding surface prior to connecting devices. The grounding screw symbol is shown below in *Figure 2.15*.



Figure 2.15 - Grounding screw symbol



Caution: Using a shielded cable achieves better electromagnetic compatibility.



Attention: L'utilisation d'un câble blindé permet une meilleure compatibilité électromagnétique

3. Mounting Installation

3.1 DIN-Rail Mounting

The DIN-Rail is pre-installed on the industrial Ethernet switch from the factory. If the DIN-Rail is not on the industrial Ethernet switch, please see *Figure 3.1* to learn how to install the DIN-Rail on the switch.

Figure 3.1
The Rear Side of the Switch and DIN-

Follow the steps below to learn how to hang the industrial Ethernet switch.

1. Use the screws to install the DIN-Rail bracket on the rear side of the industrial Ethernet switch.



Caution: The torque for tightening the screws on the device is 3.5 in-lbs.



Attention: Le couple de serrage des vis sur l'appareil est de 3.5 pouces-livres.

2. To remove the DIN-Rail bracket, do the opposite from step 1.
3. After the DIN-Rail bracket is installed on the rear side of the switch, insert the top of the DIN-Rail on to the track as shown below in *Figure 3.2*.
4. Lightly pull down the bracket on to the rail as shown below in *Figure 3.3*.
5. Check if the bracket is mounted tightly on the rail.
6. To remove the industrial Ethernet switch from the rail, do the opposite from the above steps.



Figure 3.2

Insert the Switch on the DIN-Rail

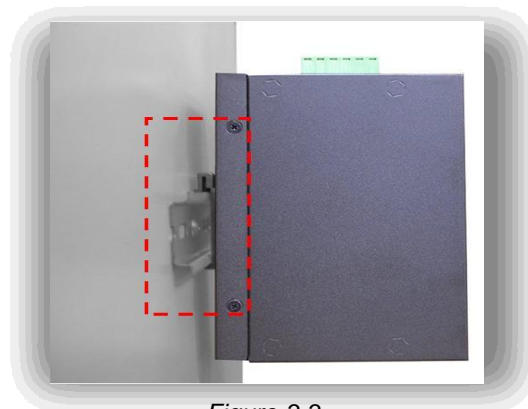

Figure 3.3

Stable the Switch on DIN-Rail

3.2 Wall Mounting

Follow the steps below to mount the industrial Ethernet switch using the wall mounting bracket as shown below in *Figure 3.4*.



Caution: "Wall" means industrial control panel wall



Attention: "Wall" signifie mur de panneau de commande industriel

1. Remove the DIN-Rail bracket from the industrial Ethernet switch by loosening the screws.
2. Place the wall mounting brackets on the top and bottom of the industrial Ethernet switch.
3. Use the screws to screw the wall mounting bracket on the industrial Ethernet switch.



Caution: The torque for tightening the screws on the device is 3.5 in-lbs.



Attention: Le couple de serrage des vis sur l'appareil est de 3.5 pouces-livres.

4. Use the hook holes at the corners of the wall mounting bracket to hang the industrial Ethernet switch on the wall.
5. To remove the wall mount bracket, do the opposite from the steps above.



Figure 3.4

Remove DIN-Rail Bracket from the Switch

Below, in *Figure 3.5* are the dimensions of the wall mounting bracket.

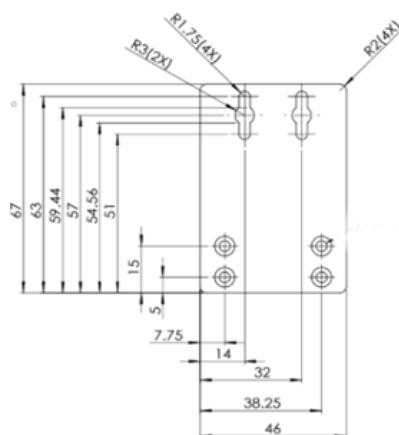

Figure 3.5

Wall Mounting Bracket Dimensions

4. Hardware Installation

4.1 Installation Steps

This section will explain how to install Antaira's LMP-1204G-SFP-bt series:



Caution: This device is intended for use indoor.



Attention: Cet appareil est destiné à être utilisé à l'intérieur.



Caution: The device is intended to be installed in an industrial control enclosure and panel.



Attention: L'appareil est destiné à être installé dans une armoire de commande et un panneau industriels.

Installation Steps

1. Unpack the industrial Ethernet switch from the original packing box.
2. Check if the DIN-Rail bracket is screwed on the industrial Ethernet switch.
 - If the DIN-Rail is not screwed on the industrial Ethernet switch, please refer to the **DIN-Rail Mounting** section for DIN-Rail installation.
 - If you want to wall mount the industrial Ethernet switch, please refer to the **Wall Mounting** section for wall mounting installation.
3. To hang the industrial Ethernet switch on a DIN-Rail or wall, please refer to the **Mounting Installation** section.
4. Power on the industrial Ethernet switch and then the power LED light will turn on.
 - If you need help on how to wire power, please refer to the **Wiring the Power Inputs** section.
 - Please refer to the **LED Indicators** section for LED light indication.
5. Prepare the twisted-pair, straight-through category 5 cable for Ethernet connection.
6. Insert one side of the RJ-45 cable into switch's Ethernet port and on the other side into the networking device's Ethernet port, e.g. switch PC or server. The Ethernet port's (RJ-45) LED on the industrial Ethernet switch will turn on when the cable is connected to the networking device.
 - Please refer to the **LED Indicators** section for LED light indication.
7. When all connections are set and the LED lights all show normal, the installation is complete.

4.2 Maintenance and Service

- If the device requires servicing of any kind, the user is required to disconnect and remove it from its mounting. The initial installation should be done in a way that makes this as convenient as possible.
- Voltage/Power lines should be properly insulated as well as other cables. Be careful when handling them so as to not trip over.
- Do not under any circumstance insert foreign objects of any kind into the heat dissipation holes located in the different faces of the device. This may not only harm the internal layout, but might cause harm to user as well.
- Do not under any circumstance open the device for any reason. Please contact your dealer for any repair needed or follow the instructions within the manual.
- Clean the device with dry soft cloth.

5. Technical Specifications

Table 5.1 has the technical specifications for Antaira's LMP-1204G-SFP-bt series:

Technology	L2 Switching	Port/MAC/Protocol/IP Subnet-based VLAN, GARP/GVRP, Loop Guard, Link Aggregation static/LACP, BPDU guard, Error disable recovery, IGMP snooping v1/v2/v3, MLD snooping v1/v2, IGMP filtering, IPMC throttling / filtering leave proxy, DHCP snooping, G.8032 v1/v2
	L3 Switching	DHCP option82, static routes
	QoS	802.1p Queueing, Input priority mapping, Storm control for Unicast/Multicast/Broadcast, Port/Queue/ACL policer, Port egress shaper, Queue egress shaper, DiffServ (DSCP), Tag remarking, Scheduler mode
	Power Saving	ActiPHY, PerfectReach, IEEE 802.3az EEE power management
	Network Redundancy	STP/RSTP/MSTP, port trunk with LACP, ERPS v1/v2 (<50ms)
	Configuration	Http, Https, Telnet, SSH, CLI, TFTP, SNMP v3
	System / Diagnostics	Dual Image Protection, PING, PING6
Switch Properties	Back-Plane (Switching Fabric)	24Gbps
	Priority Queues	8
	Processing Type	Store and Forward
	Flow Control	IEEE 802.3x for flow duplex mode, back pressure for half duplex mode
	Transfer Rate	14,880pps for Ethernet Port 148,800pps for Fast Ethernet Port 1,488,000pps for Gigabit Ethernet Port
	Memory Buffer	4Mbits
	Jumbo Frame	9.6Kbytes
	MAC Table Size	8K
	VLAN Group	4095
	IGMP Group	1024
Port Interface	Ethernet Port	8*10/100/1000Base-TX (90W/Port for Port 1~4, 30W/Port for Port 5~8), auto negotiation speed, Full/Half duplex mode, and auto MDI/MDI-X connection
	SFP Port	4*100/1000 SFP Slots
	RS232 Serial Console	1*RS232 in RJ45
	LED Indicators	System: Power 1, Power 2, Master (M), Ring (R), Status, PoE Load (P/L) Ethernet Ports: Speed/Link/Active PoE: On-connected to PD devices SFP: Link/Active
Protection	Network Cable	10Base-T: 2-pair UTP/STP Cat. 3, 4, 5 cable EIA/TIA-568 100-ohm (100m) 100Base-TX: 2-pair UTP/STP Cat. 5 cable EIA/TIA-568 100-ohm (100m) 1000Base-TX: 4-pair UTP/STP Cat.5/5E cable; EIA/TIA-568 100-ohm (100m)

Mechanical Characteristics	Housing	Metal, IP30 protection
	Dimensions	54 x 142 x 99 mm (W x H x D)
	Weight	Unit: 2.38 lbs Shipping: 3.07 lbs
	Mounting	DIN-Rail, Wall-mount (Optional)
Power Requirement	Input Voltage	48~55VDC Redundant Input
	Power Connection	Removable 6-contact terminal block
	Relay Contact	24VDC, 1A resistive
	Overload Current Protection	Present
	Reverse Polarity Protection	Present
	PoE Pin Assignment	V-, V-, V+, V+ for pin 1, 2, 3, 6; V+, V+, V-, V- for pin 4, 5, 7, 8 *Support Modes: Mode A, Mode B, 4-Pair Mode
	PoE Power Budget	240W @48~55VDC
	System Power Consumption	12.5W
Environment Limits	Operating Temperature	STD: -10°C to 65°C EOT: -40°C to 75°C
	Storage Temperature	-40°C to 85°C
	Ambient Relative Humidity	5% to 95%, (non-condensing)
Regulatory Approvals	EMI	FCC Part 15 Subpart B Class A, CE EN55032/EN61000-6-4 Class A
	EMS	CE EN55035/EN61000-6-2 Class A, IEC61000-4-2,3,4,5,6,8
	Free Fall	IEC60068-2-32
	Shock	IEC60068-2-27
	Vibration	IEC60068-2-6
	Green	RoHS Compliant
	Certifications	FCC, CE, NEMA TS2
	Warranty	5 Years
	Safety	UL 61010-1, UL 61010-2-201

Table 5.1 - LMP-1204G-SFP-bt Series Technical Specifications

Antaira Customer Service and Support

(Antaira US Headquarter) + 844-268-2472

(Antaira Europe Office) + 48-22-862-88-81

(Antaira Asia Office) + 886-2-2218-9733

Please report any problems to Antaira:www.antaira.com / support@antaira.comwww.antaira.eu / info@antaira.eu

