



**16-port 10/100TX + 2-Port 10/100/1000T**

**Mini-GBIC Combo**

**Industrial Ethernet Switch**



**User Manual**

## **FCC Warning**

This Equipment has been tested and found to comply with the limits for a Class-A digital device, pursuant to Part 15 of the FCC rules. These limits are designed to provide reasonable protection against harmful interference in a residential installation. This equipment generates, uses, and can radiate radio frequency energy. It may cause harmful interference to radio communications if the equipment is not installed and used in accordance with the instructions. However, there is no guarantee that interference will not occur in a particular installation. If this equipment does cause harmful interference to radio or television reception, which can be determined by turning the equipment off and on, the user is encouraged to try to correct the interference by one or more of the following measures:

- Reorient or relocate the receiving antenna.
- Increase the separation between the equipment and receiver.
- Connect the equipment into an outlet on a circuit different from that to which the receiver is connected.
- Consult the dealer or an experienced radio/TV technician for help.

## **CE Mark Warning**

This is a Class-A product. In a domestic environment this product may cause radio interference in which case the user may be required to take adequate measures.

# Content

---

<b>Introduction</b> .....	<b>1</b>
Features .....	1
Package Contents.....	2
<b>Hardware Description</b> .....	<b>3</b>
Physical Dimension.....	3
Front Panel .....	3
Top View .....	4
LED Indicators .....	4
Ports.....	6
Cabling.....	8
Wiring the Power Inputs .....	12
Wiring the Fault Alarm Contact .....	13
<b>Mounting Installation</b> .....	<b>14</b>
DIN-Rail Mounting.....	14
Wall Mount Plate Mounting .....	16
<b>Hardware Installation</b> .....	<b>17</b>
Installation Steps.....	17
<b>Network Application</b> .....	<b>18</b>
<b>Troubles shooting</b> .....	<b>19</b>
<b>Technical Specification</b> .....	<b>20</b>

# Introduction

---

The 16 10 /100TX + 2 1 0/100/1000T/Mini-GBIC Combo Industrial Switch is a cost-effective solution and meets the high reliability requirements demanded by industrial applications. Using fiber port can extend the connection distance that increases the network elasticity and performance.

## Features

- System Interface/Performance
  - RJ-45 ports support Auto MDI/MDI-X Function
  - SFP (mini-GBIC) supports 100/1000 Dual Mode
  - Store-and-Forward Switching Architecture
  - Back-plane (Switching Fabric): 7.2Gbps
  - 1Mbits Packet Buffer
  - 8K MAC Address Table
  - Supports Wide Operating Temperature (-40°C ~ 75°C)
- Case/Installation
  - IP-30 Protection
  - DIN-Rail and Wall Mount Design
- Power Supply
  - Wide Range Redundant Power Design
  - Power Polarity Reverse Protect
  - Overload Current Protection
- Provides EFT protection 3,000 V<sub>DC</sub> for power line
- Supports 6,000 V<sub>DC</sub> Ethernet ESD protection

## Package Contents

Please refer to the package content list below to verify them against the checklist.

- 16 10/100TX + 2 10/100/1000T/Mini-GBIC Combo Industrial Switch
- Pluggable Terminal Block
- User manual
- 2 wall mount plates with screws
- One DIN-Rail (attached on the switch)

Compare the contents of the industrial switch with the standard checklist above. If any item is damaged or missing, please contact the local dealer for service.

# Hardware Description

---

In this paragraph, it will describe the Industrial switch's hardware spec, port, cabling information, and wiring installation.

## Physical Dimension

16 10/100TX + 2 10/100/1000T/Mini-GBIC Combo Industrial Switch dimension (W x D x H) is **72mm x 105mm x 152mm**

## Front Panel

The front panel of the 16 10/100TX + 2 10/100/1000T/Mini-GBIC Combo Industrial Switch is shown as below:

### **Warning!**

Airflow around the switch must be unrestricted. To prevent the switch from overheating, there must be the following minimum clearances:

- Top and bottom: 2.0 in. (50.8 mm)
- Sides: 2.0 in. (50.8 mm)
- Front: 2.0 in. (50.8 mm)

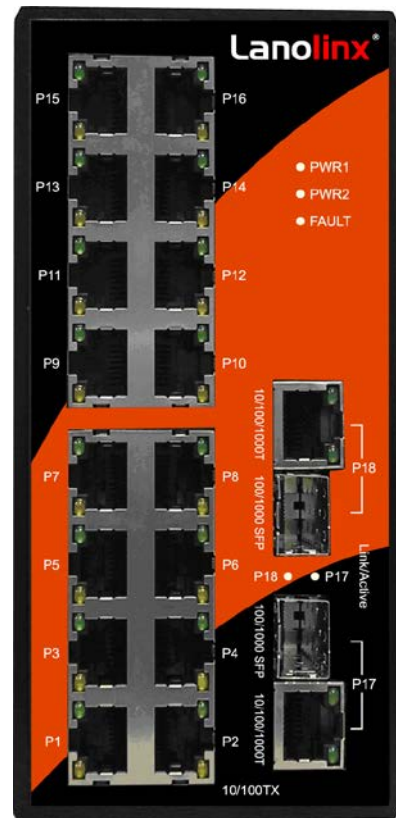

Front Panel of the industrial switch

## Top View

The top panel of the 16 10/100TX + 2 10/100/1000T/Mini-GBIC Combo Industrial Switch has one terminal block connector of two DC power inputs.



Top Panel of the industrial switch

## LED Indicators

The diagnostic LEDs located on the front panel of the industrial switch provide real-time information of system and optional status. The following table provides description of the LED status and their meanings for the switch.

LED	Status	Meaning
PWR1	Green	Power 1 is active
	Off	Power 1 is inactive
PWR2	Green	Power 2 is active
	Off	Power 2 is inactive
Fault	Red	PWR1/PWR2 is inactive

	Off	PWR1 & PWR2 are both active or no power inputs
<b>P1 ~ P16</b>	Green (Upper LED)	Connected to network
	Blinking (Upper LED)	Networking is active
	Off (Upper LED)	Not connected to network
	Yellow (Lower LED)	Ethernet port full duplex
	Blinking (Lower LED)	Collision of packets occurs
	Off (Lower LED)	Ethernet port half duplex or not connected to network
<b>P17 ~ P18 (10/100/1000T)</b>	Green (Upper LED)	Connected to network
	Blinking (Upper LED)	Networking is active
	Off (Upper LED)	Not connected to network
	Green (Lower LED)	The port is operating at speed of 1000M
	Off (Lower LED)	The port is disconnected or operates at speed of 10/100M
<b>P17 ~ P18 Link/Active (100/1000 SFP)</b>	Green	SFP port is connected to network
	Blinking	Networking is active
	Off	Not connected to network



# Ports

## ■ RJ-45 ports

The UTP/STP ports will auto-sense for 10Base-T/100Base-TX connections (Fast Ethernet) or 10Base-T, 100Base-TX, or 1000Base-T connections (Gigabit Ethernet). Auto MDI/MDIX means that the switch can connect to another switch or workstation without changing straight through or crossover cabling. See the figures below for straight through and crossover cable schematic.

## ■ RJ-45 Pin Assignments

Pin Number	Assignment
1	Tx+
2	Tx-
3	Rx+
6	Rx-

---

**Note** “+” and “-” signs represent the polarity of the wires that make up each wire pair.

---

All ports on this industrial switch support automatic MDI/MDI-X operation, user can use straight-through cables (See figure below) for all network connections to PCs or servers, or to other switches or hubs. In straight-through cable, pins 1, 2, 3, and 6, at one end of the cable, are connected straight through to pins 1, 2, 3 and 6 at the other end of the cable. The table below shows the MDI and MDI-X port pin outs.

Pin MDI-X	Signal Name	MDI Signal Name
1	Receive Data plus (RD+)	Transmit Data plus (TD+)
2	Receive Data minus (RD-)	Transmit Data minus (TD-)
3	Transmit Data plus (TD+)	Receive Data plus (RD+)
6	Transmit Data minus (TD-)	Receive Data minus (RD-)

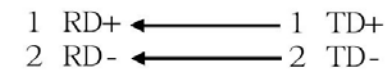
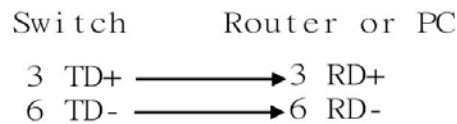

Straight Through Cable Schematic

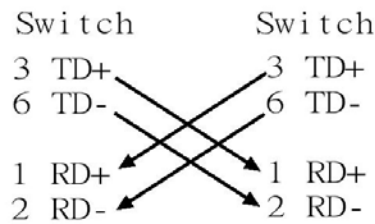

Cross Over Cable Schematic

■ **2 Gigabit Copper/SFP (Mini-GBIC) combo port:**

The Industrial switch has two auto-detected Gigabit ports—UTP/STP/Fiber combo ports. The Gigabit Copper (10/100/1000T) ports should use Category 5e or above UTP/STP cable for the connection up to 1000Mbps. The SFP slots supporting dual mode can switch the connection speed between 100 and 1000Mbps. They are for connecting to the network segment with single or multi-mode fiber. You can choose the appropriate mini-GBIC module to plug into the slots. You can use proper multi-mode or single-mode fiber according to the used SFP module. With fiber optic, it transmits speed up to 1000 Mbps and you can prevent noise interference from the system and transmission distance up to 110 km, depending on the mini-GBIC module.

The small form-factor pluggable (SFP) is a compact optical transceiver used in optical communications for both telecommunication and data communications applications.

---

**Note** *The SFP/Copper Combo module can't both be used at the same time. The SFP module has the higher priority than copper module; if you insert the 1000M SFP transceiver into the SFP module which is connected to the remote device, the connection of the accompanying copper port will link down. If you insert the 100M SFP transceiver into the SFP module even without a fiber connection to the remote, the connection of the accompanying copper port will link down immediately.*

---

## Cabling

Twisted-pair segment can be established by using unshielded twisted pair (UTP) or shielded twisted pair (STP) cabling. The cable between the link partner (switch, hub, workstation, etc.) and the converter must be less than 100 meters (328 ft.) long and comply with the IEEE 802.3ab 1000Base-T standard for Category 5e or above.

Fiber segment using single-mode connector type must use 9/125 $\mu$ m single-mode fiber cable. You can connect two devices in the distance of 10 km. Fiber segment using multi-mode connector type must use 50/125 or 62.5/125 $\mu$ m multi-mode fiber cable. You can connect two devices up to 550m distances.

The small form-factor pluggable (SFP) is a compact optical transceiver used in optical communications for both telecommunication and data communication applications.

To connect the transceiver and LC cable, please follow the steps shown below:

First, insert the transceiver into the SFP module. Notice that the triangle mark is the bottom of the module.

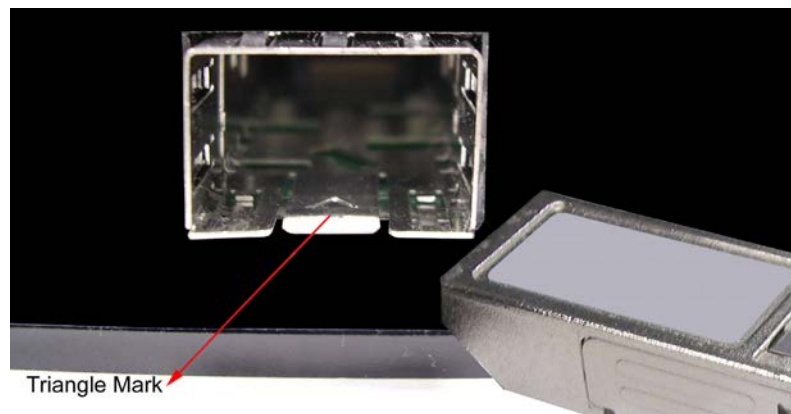

*Figure 2.8: Transceiver to the SFP module*

Make sure the module is aligned correctly and then slide the module into the SFP slot until a click is heard.



*Figure 2.9: Transceiver Inserted*

Second, insert the fiber cable of LC connector into the transceiver.

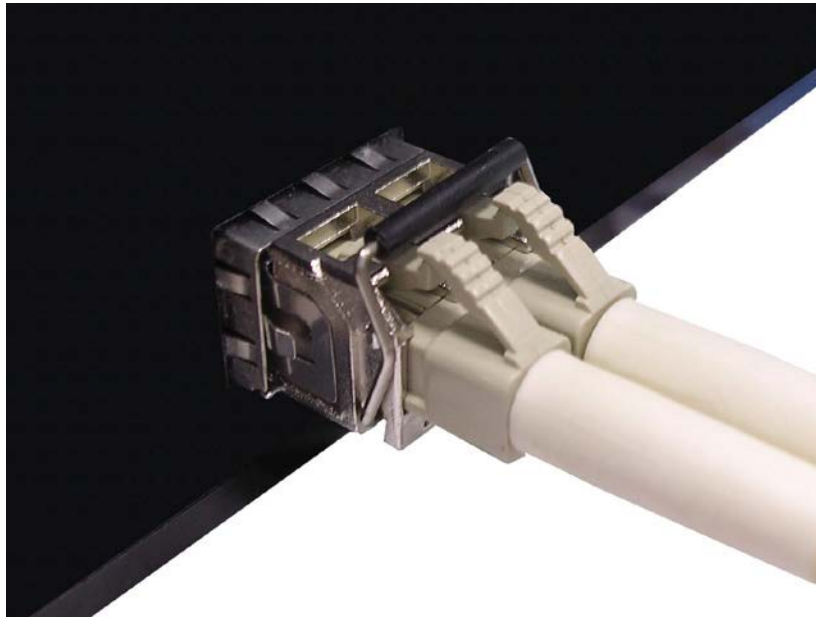

*Figure 2.10: LC connector to the transceiver*

To remove the LC connector from the transceiver, please follow the steps shown below:

First, press the upper side of the LC connector from the transceiver and pull it out to release.

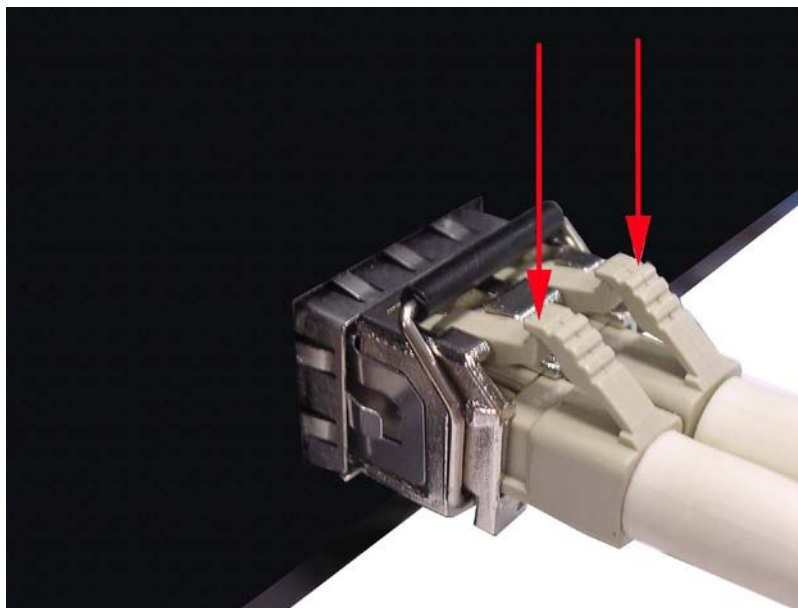

*Figure 2.11: Remove LC connector*

Second, push down the metal loop and pull the transceiver out by the plastic part.

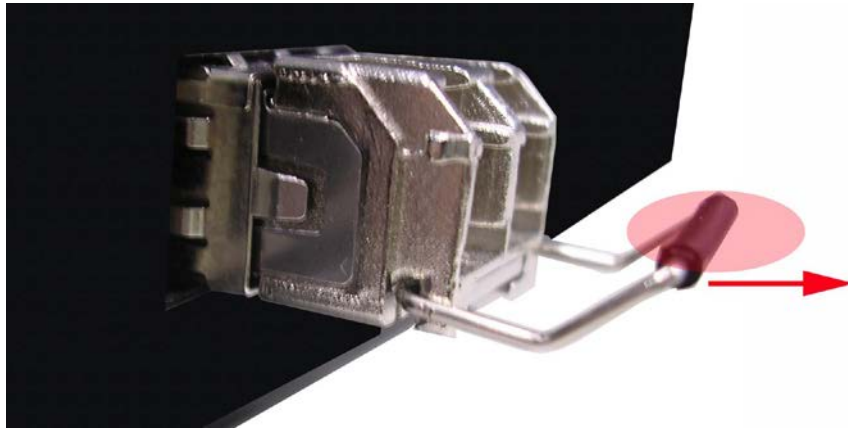

*Figure 2.12: Pull out from the SFP module*

## Wiring the Power Inputs

Please follow the steps below to insert the power wire.

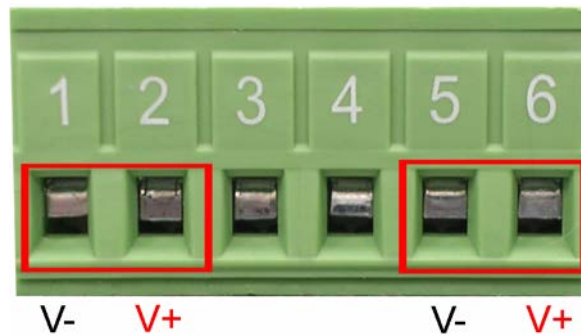

1. Insert the positive and negative wires into the V+ and V- contacts on the terminal block connector.

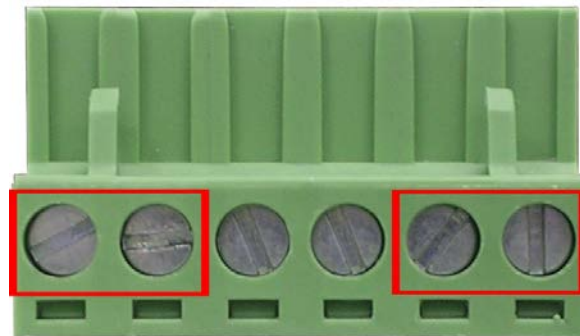

2. To tighten the wire-clamp screws for preventing the DC wires to loose.

## Wiring the Fault Alarm Contact

The fault alarm contact is in the middle of terminal block connector as the picture shows below. Inserting the wires, it will detect the fault status which the power is failure or port link failure (for managed model) and form an open circuit.

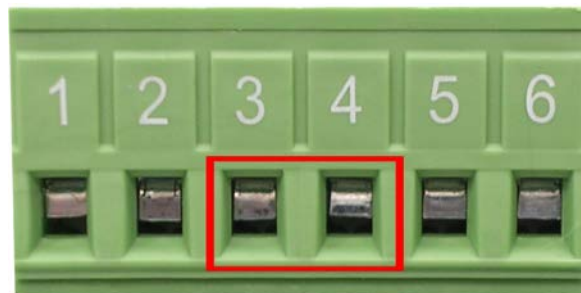

Insert the wires into the fault alarm contact (No. 3 & 4)

---

**Note**     *The wire gauge for the terminal block should be in the range between 12~ 24 AWG.*

---



# Mounting Installation

---

## DIN-Rail Mounting

The DIN-Rail is screwed on the industrial switch when out of factory. If the DIN-Rail is not screwed on the industrial switch, please see the following pictures to screw the DIN-Rail on the switch. Follow the steps below to hang the industrial switch.

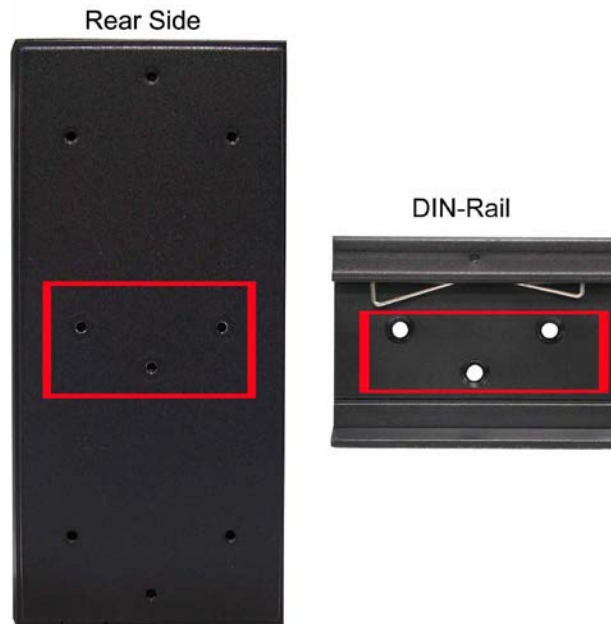

1. First, insert the top of DIN-Rail into the track.

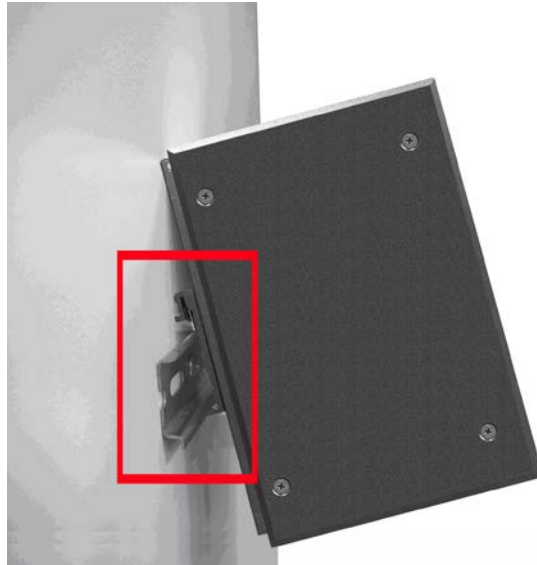

2. Then, lightly push the DIN-Rail into the track.

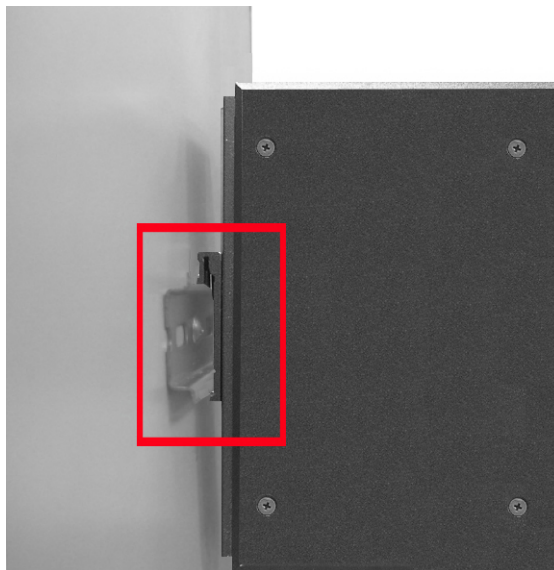

3. Check if the DIN-Rail is tightened on the track or not.
4. To remove the industrial switch from the track, reverse steps above.

## Wall Mount Plate Mounting

---

Follow the steps below to mount the industrial switch with wall mount plate.

1. Remove the DIN-Rail from the industrial switch; loose the screws to remove the DIN-Rail.
2. Place the wall mount plate on the rear panel of the industrial switch.
3. Use the screws to screw the wall mount plate on the industrial switch.
4. Use the hook holes at the corners of the wall mount plate to hang the industrial switch on the wall.
5. To remove the wall mount plate, reverse the steps above.

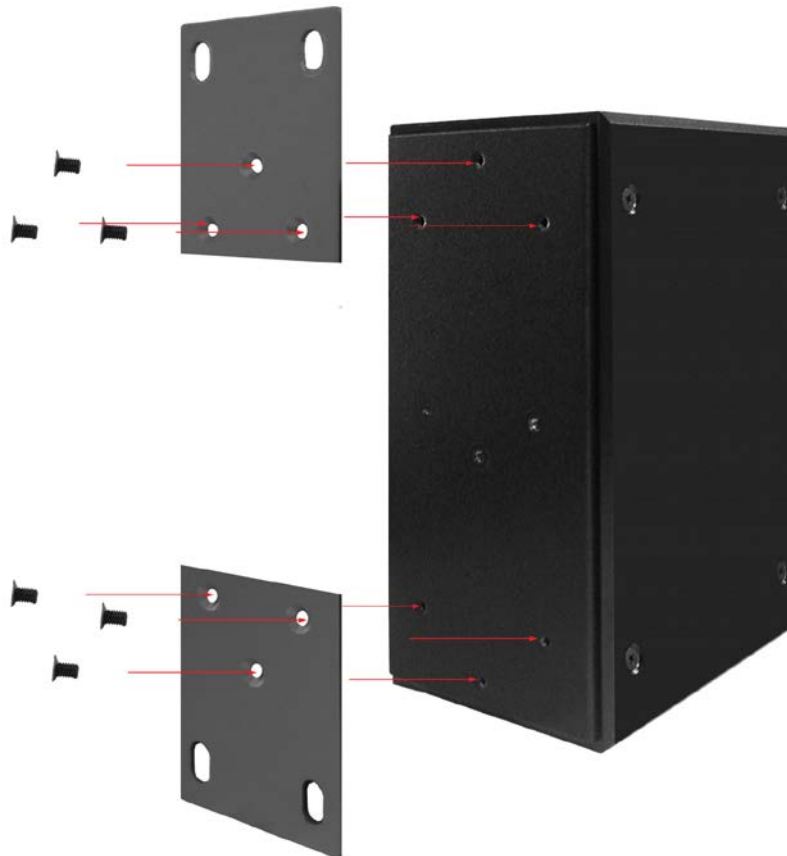

# Hardware Installation

---

In this paragraph, we will describe how to install the 16 10 /100TX + 2 10/100/1000T/Mini-GBIC Combo Industrial Switch and the installation points to be attended to it.

## Installation Steps

1. Unpack the Industrial switch packing.
2. Check if the DIN-Rail is screwed on the Industrial switch or not. If the DIN-Rail is not screwed on the Industrial switch, please refer to **DIN-Rail Mounting** section for DIN-Rail installation. If the user wants to wall mount the Industrial switch, then please refer to **Wall Mount Plate Mounting** section for wall mount plate installation.
3. To hang the Industrial switch on the DIN-Rail track or wall, please refer to the **Mounting Installation** section.
4. Power on the Industrial switch. Please refer to the **Wiring the Power Inputs** section for knowing the information about how to wire the power. The power LED on the Industrial switch will light up. Please refer to the **LED Indicators** section for indication of LED lights.
5. Prepare the twisted-pair, straight through Category 5 /above cable for Ethernet connection.
6. Insert one end of UTP/STP cable into the Industrial switch RJ-45 port and the other end to the network device's RJ-45 port, e.g. Switch PC or Server. The RJ-45 port LED on the Industrial switch will light up when the cable is connected with the network device. Please refer to the **LED Indicators** section for LED light indication.
7. When all connections are set and LED lights all show in normal, the installation is complete.

# Network Application

---

This chapter provides some sample applications to help user to have more actual idea of industrial switch function application. A sample application of the industrial switch is shown as below:

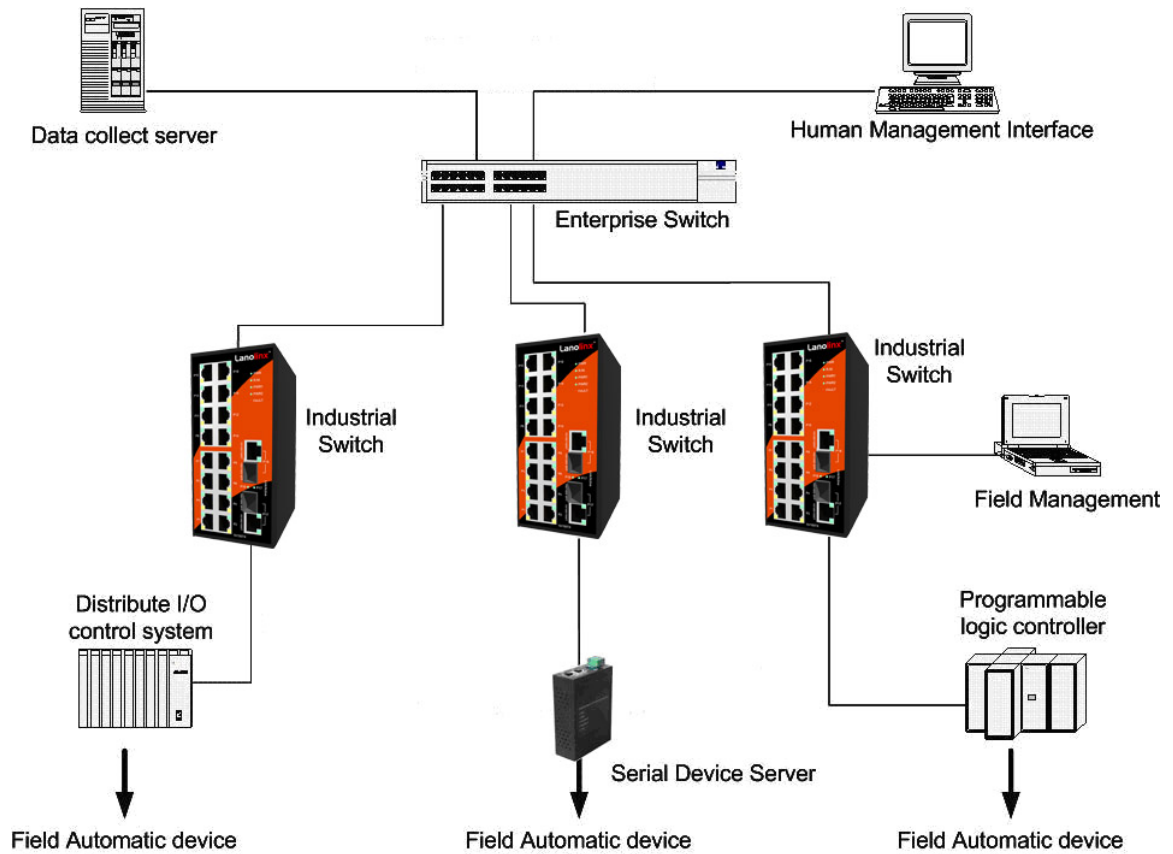

# Troubleshooting

---

- Verify that you are using the right power cord/adaptor (DC 12-48V). Please don't use the power adapter with DC output higher than 48V, or this switch will be burned down.
- Select the proper UTP/STP cable to construct the user network. Use unshielded twisted-pair (UTP) or shield twisted-pair (STP) cable for RJ-45 connections: 100Ω Category 3, 4 or 5 cable for 10Mbps connections, 100Ω Category 5 cable for 100Mbps connections, or 100Ω Category 5e/above cable for 1000Mbps connections. Also be sure that the length of any twisted-pair connection does not exceed 100 meters (328 feet).
- **Diagnosing LED Indicators:** To assist in identifying problems, the switch can be easily monitored through panel indicators, which describe common problems the user may encounter and where the user can find possible solutions.
- If the power indicator does not light on when the power cord is plugged in, you may have a problem with power cord. Then check for loose power connections, power losses or surges at power outlet. If you still cannot resolve the problem, contact the local dealer for assistance.
- If the LED indicators are normal and the connected cables are correct but the packets still cannot be transmitted. Please check the user system's Ethernet devices' configuration or status.

# Technical Specification

The 16 1 0/100TX + 2 1 0/100/1000T/Mini-GBIC Combo Industrial Switch technical specification are as follows.

<b>Standard</b>	IEEE 802.3 10Base-T IEEE 802.3u 100Base-TX IEEE 802.3ab 1000Base-T IEEE 802.3z Gigabit fiber IEEE 802.3x Flow Control and Back-pressure
<b>Protocol</b>	CSMA/CD
<b>Transfer Rate</b>	14,880 pps for 10Base-T Ethernet port 148,800 pps for 100Base-TX/FX Fast Ethernet port 1,488,000 pps for Gigabit Fiber Ethernet port
<b>MAC address</b>	8K MAC address table
<b>Packet Buffer</b>	1Mbits
<b>LED</b>	<b>Per unit:</b> Power 1 (Green), Power 2 (Green), Fault (Red) <b>16 10/100TX:</b> Link/Activity (Green), Full duplex/Collision (Yellow) <b>Gigabit Copper:</b> Link/Activity (Green), speed (1000M Green) <b>SFP:</b> Link/Activity (Green)
<b>Network Cable</b>	10Base-T: 2-pair UTP/STP Cat. 3, 4, 5 cable EIA/TIA-568 100-ohm (100m) 100Base-TX: 2-pair UTP/STP Cat. 5 cable EIA/TIA-568 100-ohm (100m) 1000Base-T: 2-pair UTP/STP Cat. 5e or 6 cable EIA/TIA-568 100-ohm (100m)

<b>Optical cable</b>	<ul style="list-style-type: none"> <li>■ <b>LC (Multi-mode):</b> 50/125um or 62.5/125um</li> <li>■ <b>LC (Single mode):</b> 9/125um</li> </ul>
<b>Back-plane</b>	7.2Gbps
<b>Packet throughput ability</b>	10.7Mpps at 64bytes
<b>Power Supply</b>	<p>12 ~ 48 V<sub>DC</sub></p> <p>Redundant power with polarity reverse protection and removable terminal block</p> <p>(The power supply should meet the “document listed by UL” and its output must comply with L.P.S)</p>
<b>Power Consumption</b>	9 Watts
<b>Install</b>	DIN rail kit for DIN-type cabinet and wall mount ear for wall mount install
<b>Operating Temp.</b>	<p>-10°C to 60°C (standard model)</p> <p>-40°C to 75°C (wide operating temperature model)</p>
<b>Operating Humidity</b>	5% to 95% (Non-condensing)
<b>Storage Temperature</b>	-40°C to 85°C
<b>Case Dimension</b>	IP-30, 72 mm (W) x 105 mm (D) x 152mm (H)
<b>EMI</b>	<p>FCC Class A</p> <p>CE EN61000-4-2 (ESD)</p> <p>CE EN61000-4-3 (RS)</p> <p>CE EN61000-4-4 (EFT)</p> <p>CE EN61000-4-5 (Surge)</p> <p>CE EN61000-4-6 (CS)</p> <p>CE EN61000-4-8</p> <p>CE EN61000-4-11</p>



	CE EN61000-4-12 CE EN61000-6-2 CE EN61000-6-4
<b>Safety</b>	UL 60950-1
<b>Stability testing</b>	IEC60068-2-32 (Free fall) IEC60068-2-27 (Shock) IEC60068-2-6 (Vibration)